

# “SPEEDY” PERSONAL SPEED RADAR KIT

**Ramsey Electronics Model No.                      SG7**

*YOU BE THE COP! “CLOCK” CARS, BIKES, PLANES, HORSES, JOGGERS, VIRTUALLY ANYTHING THAT MOVES! WORKS ON THE SAME PRINCIPLE AS POLICE UNITS COSTING THOUSANDS MORE. IDEAL FOR LEARNING AND TEACHING RADAR THEORY.*

- **Direct readout in Miles, Kilometers or Feet per second**
- **Operates on 12 volts DC**
- **1/4 mile range with average size car**
- **Better than 2 miles per hour accuracy, reads to over 200 MPH**
- **Operates on 2.6GHz - no license needed**
- **Earphone output to actually hear Doppler shift**
- **The Nation’s #1 science fair project!**
- **Clear, concise step-by-step instructions guide you to a finished kit that not only works FIRST time - but you’ll also learn!**
- **Complete kit includes case and cables - just add two coffee or juice cans**
- **Sets off cheap radar detectors - lots of highway fun!**

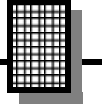

### RAMSEY TRANSMITTER KITS

- FM100B Professional FM Stereo Transmitter
- FM25B Synthesized Stereo FM Transmitter
- MR6 Model Rocket Tracking Transmitter
- TV6 Television Transmitter

### RAMSEY RECEIVER KITS

- FR1 FM Broadcast Receiver
- AR1 Aircraft Band Receiver
- SR2 Shortwave Receiver
- SC1 Shortwave Converter

### RAMSEY HOBBY KITS

- SG7 Personal Speed Radar
- SS70A Speech Scrambler
- BS1 "Bullshooter" Digital Voice Storage Unit
- AVS10 Automatic Sequential Video Switcher
- WCT20 Cable Wizard Cable Tracer
- LC1 Inductance-Capacitance Meter

### RAMSEY AMATEUR RADIO KITS

- DDF1 Doppler Direction Finder
- HR Series HF All Mode Receivers
- QRP Series HF CW Transmitters
- CW7 CW Keyer
- CPO3 Code Practice Oscillator
- QRP Power Amplifiers

### RAMSEY MINI-KITS

Many other kits are available for hobby, school, Scouts and just plain FUN. New kits are always under development. Write or call for our free Ramsey catalog.

#### SG7 PERSONAL SPEED RADAR KIT INSTRUCTION MANUAL

Ramsey Electronics publication No. MSG7 Revision 1.2

First printing: February 1995



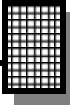

---

# KIT ASSEMBLY AND INSTRUCTION MANUAL FOR

# SG7 PERSONAL SPEED RADAR

## TABLE OF CONTENTS

Work involved in building the SG7.....	4
Doppler description .....	5
Parts list .....	7
Signal cable assembly .....	9
Power supply notes.....	10
LED schematic diagram .....	12
LED unit PC layout.....	13
Assembling the LED unit.....	14
Assembling the microwave unit .....	20
Microwave unit PC layout.....	11
Shield assembly.....	24
Microwave oscillator PC board.....	26
Can selection and details .....	27
Testing and calibration .....	29
Troubleshooting hints.....	31
SG7 statistics and specs.....	32
Ramsey kit warranty.....	34



## **PLEASE, PLEASE READ THIS!**

THANK YOU for purchasing the SG7 Speedy Radar Gun. This is a kit project that we're especially proud of. We've packed a lot of value into it, and we know you have paid good money for it and that you sure do expect it to work.

Speedy will be a very satisfying project for you - IF you are willing to follow our directions carefully. This is definitely not one of those kits where you can expect to just put some parts on a board and tinker as you go along. Mechanical details are just as critical as correct component soldering.

- There are several reasons why following directions are so important for this kit. Of course, you and I both want it to "work". In addition:
- Both you and I want the Display PC board to fit correctly in its custom-made case. For example, if you jump ahead and install the electrolytic capacitors in the conventional way, the board will NOT fit in the case.
- Both you and I want Speedy to LOOK GOOD when it's finished.
- Both you and I want it to be mechanically durable, so it can be USED reliably when and where you want to use it.
- Please realize that physical and mechanical details are MUCH more critical at 2600 MHz than in frequency ranges more familiar to most electronics and radio experimenters!

Our directions are designed to help you accomplish all these goals. Please follow them carefully!

## **BUILDING THE SG7 - A LOOK AT THE WORK TO DO:**

Since there are a variety of steps in completing your Personal Radar, let's look over the big picture briefly. An operational SG7 consists of three basic devices: the LED Speed Readout unit, the Microwave Oscillator-Antenna unit, and a convenient 12 volt power pack (200mA or more) provided by you.

The SG7A Speed Readout unit involves fairly conventional PC board soldering. Following our directions is VERY important for getting a good fit of the board into its custom case so that it fits correctly.

The SG7B Microwave Oscillator-Antenna PC board involves a mix of both thru-the-board leads and surface soldering typical of UHF and microwave designs. Even though it's not a quickie "stick-in-the-parts" job, it goes together more easily than you might think, and we'll be with you every step of the way.

A pre-cut piece of real, honest, shiny tin is supplied for use in forming a shield and casing around the component side of the Microwave Oscillator board. It is

soldered in place very easily, so long as its creases are formed carefully.

The oscillator board, enclosed in its tin shield, is soldered to a metal can assembly that has been prepared with TLC (Tender Loving Care). You will find that both the oscillator shield and the can will solder very easily. After all, tin is a major ingredient of solder. A 1.1" length of buss wire (supplied) extends through a hole in the can from the oscillator board to serve as the 2600MHz antenna in conjunction with the can itself!

A shielded 2-conductor cable and plug set (all parts supplied in the kit) interconnects the LED Speed Counter unit and the radar gun itself.

Your SG7 Kit includes everything needed except 12V battery pack, battery cable (a correct DC power plug IS supplied), and the two metal cans needed to form the radar gun antenna housing. Included with your kit are the case and hardware along with the front panel graphic for a nifty looking, finished off unit.

We'll give you a few ideas on how to make your SG7 Personal Speed Radar unit as portable and practical as possible, but we know you will come up with ideas of your own, too.

## **JUST IN CASE YOU DIDN'T KNOW...**

There are many kinds of "radar" (Radio Detecting and Ranging) systems, most of them associated with aviation and military applications. These types of radars bring up images of domes, spinning antennas and radar screens. Your SG7 SPEEDY is a type of portable radar system, typical of speed monitoring equipment used in law enforcement, sports, and boating which rely on the "Doppler effect".

The Doppler effect, first investigated by Austrian physicist C.J. Doppler in 1842, is observed in ANY kind of wave motion: sound, light or radio waves. Here is a definition to chew on:

The Doppler effect is the observed change in frequency of a waveform caused by a time rate of change due to the effective distance traveled by the wave between the source and the point of observation. As the time rate of distance between you and a source of constant vibration decreases, the received frequency is greater. As the time rate of distance increases, the frequency decreases.

Imagine in your mind what you actually hear while a race car zooms past your fixed position. Can you hear that change of "varooom..." pitch and mimic it? Now, ask yourself how the car sounded to the driver all along as you heard the changing pitch of the zoom! This is one common example of the Doppler effect. The whistle of a passing train is another example.

A Doppler radar measures the velocity of a moving object by doing something useful with the detected shift in carrier frequency of the returned or "echo" signal. The shift is proportionate to the speed of the object as it approaches or moves away.

An easy way to understand what a Doppler radar actually does is to think about how one of our other kits actually works- the much simpler but fun and practical MD-3 Microwave Motion Detector or "intrusion Alarm". Like the SG7, the MD-3 employs a microwave oscillator radiating a microwave signal from a tiny wire antenna. (The MD-3 runs at 960MHz, rather than in the 2.6GHz spectrum of the SG7.)

Picture what is really going on with the MD-3 turned on in a room where every object is still. The receiver portion of the circuit hears all the echoes, and they all stay the same. If someone enters the space, the receiver detects the returned or echo signal at a frequency different enough to trigger its switching or alarm circuitry. While it does not measure or count, the receiver has detected the Doppler shift! For each mile per hour that a target is traveling toward the radar speed gun, the echo signal will be shifted 7.76 Hertz higher. If an oncoming car is traveling at 50 mph, the echo or reflected signal will be 388 Hz higher than the original, and it is this difference which the frequency counter converts to a miles-per-hour reading. If the oncoming target's speed varies, the SG7 counter can update the readout every 1/7 second. Other readouts such as Kilometers/Hour are possible by changing R21 in series with the Calibration potentiometer.

The earphone jack is much more than a novelty. This audio output is the FM modulated Doppler shift difference in Hertz between the transmitted signal and the reflected signal. In addition to "just listening" to the output frequency, you can connect this audio sampling of the Doppler shift to an interesting variety of other devices including standard Ramsey Frequency Counters, or (for higher speeds) audio tone decoders such as our inexpensive TD-1 Tone Decoder Kit. For example, if the TD-1 is adjusted to trigger with a 621 Hz input tone, it might be used with the SG7 to sound an alarm if a target hits 80 Mph! ( $80 \times 7.76 = 620.8$  Hz). Pretty neat, huh?

## **The World Beyond 99 MPH?**

The SG7's two-digit LED display directly counts to 99 MPH or other calibrated unit of speed/time. At 100 MPH and beyond, the counter "rolls over" just like the gas pumps (and drivers) that never dreamed that fuel would go above a dollar a gallon. We do not have hard data on how far beyond 100 MPH you can continue to count accurately. However, you can find out by correlating the monitored Doppler shift frequency with the indicated SG7 two-digit readings and known high-speed targets such as airplanes on approach.

## PARTS LIST:

### **LED SPEED READOUT PC BOARD:**

#### CAPACITORS

- 1 100pF capacitor (marked 100 or 101) (C16)
- 1 2200pF disc capacitor (marked .0022 or 2200 or 222) (C5)
- 1 .005 $\mu$ F capacitor (marked .005 or 5000 or 502) (C1)
- 2 .001 $\mu$ F capacitors (marked .001 or 102) (C3,C11)
- 6 .01 $\mu$ F capacitors (marked .01 or 103 or 10nf) (C4,13,15,17,18,19)
- 2 .047 or .05 $\mu$ F capacitors (marked .047 or 473, .05 marked .05 or 503) (C7,C8)
- 5 10 $\mu$ F electrolytic (C6,9,10,14,21)
- 1 22 $\mu$ F electrolytic (C20 - see text)
- 1 33 $\mu$ F electrolytic (C20- see text)
- 2 100 or 220 $\mu$ F electrolytic (C2,C12)

#### RESISTORS

- 1 100 ohm [brown-black-brown] (R11)
- 3 220 ohm [red-red-brown] (R23,24,27)
- 1 3.3K ohms [orange-orange-red] (R12)
- 2 4.7K ohms [yellow-violet-red] (R25,R26)
- 4 10K ohms [brown-black-orange] (R5,14,17,21)
- 2 22K ohms [red-red-orange] (R8,R9)
- 7 47K ohms [yellow-violet-orange] (R1,2,3,4,13,18,20)
- 5 100K ohms [brown-black-yellow] (R7,15,16,28,19)
- 1 1 megohm [brown-black-green] (R6)
- 1 2.2K ohms potentiometer (GAIN, R10)
- 1 10K ohms potentiometer (CALIBRATION, R22)

#### SEMICONDUCTORS

- 1 2N3904 NPN transistor (Q1)
- 1 LM324 Quad op-amp IC (U1)
- 1 4093 Quad Schmitt trigger NAND IC (U2)
- 1 4011 Quad NAND IC (U3)
- 1 4518 Dual BCD decade counter IC (U4)
- 2 4511 BCD to 7 segment LED driver IC (U5,U6)
- 1 1N4002 1 amp diode (D2)
- 1 1N4148 glass bead signal diode (D1)
- 2 7-segment LED display (U7,U8)

## OTHER COMPONENTS

- 1 SG7 printed circuit board
- 1 Case kit
- 1 Miniature stereo (signal) jack (J1)
- 4 case screws
- 1 Subminiature phone jack (J2)
- 4 3/8" threaded standoffs
- 1 DC coaxial power jack (J3)
- 8 #4 screws
- 1 Stereo (signal) plug
- 1 front panel decal
- 1 power plug (may include wire)
- 1 5 feet of 2 conductive shielded hookup wire

## **MICROWAVE OSCILLATOR PC BOARD:**

### CAPACITORS

- 3 .01 $\mu$ F disc capacitor (marked .01 or b103 or 10nf) (C1,2,6)
- 1 .001 $\mu$ F SMT chip capacitor (C7, factory-installed on board)
- 2 1 $\mu$ F electrolytic (C4,C5)
- 1 220 $\mu$ F electrolytic (C3)

### RESISTORS

- 2 100 ohms [brown-black-brown] (R4,R5)
- 1 1K ohms [brown-black-red] (R3)
- 2 10K ohms [brown-black-orange] (R1,R6)
- 1 1 megohm [brown-black-green] (R2)

### SEMICONDUCTORS

- 1 2N3904 NPN transistor (Q1)
- 1 NE021 microwave transistor (Q2)
- 1 1N4148 glass bead signal diode (D1)
- 1 1SS99 hot carrier diode (very small, marked with black and blue color bands) (D2)

## OTHER COMPONENTS

- 1 SG7B printed circuit board
- 1 Miniature stereo jack
- 1 Miniature stereo plug
- 1 Length of No. 20 buss wire (for 1.1" antenna)
- 1 Pre-cut tin cover shield

## REQUIRED, NOT SUPPLIED

- Metal cans for housing (see text)
- 12-14 VDC, 200 mA. battery pack or other DC supply.

## **ASSEMBLING THE 2-CONDUCTOR SIGNAL CABLE:**

Your SG7 kit includes two plugs and a length of 2-conductor shielded cable for making the custom cable connect the Speed Readout Unit to the Microstrip Oscillator. Assembly of this cable is a good warm-up job and its nice to have it ready when it's time to do our serious testing.

While making up this cable will be a very obvious procedure for many builders, here are some hints for those who will appreciate them:

- ❑ 1. Once the outer shell is screwed onto a plug, it may look good but any bad work will be completely hidden - and will begin to cause problems right away.
- ❑ 2. The most common cause of problems in computer and ham radio station installations are merely bad cable assemblies, whether RF coax, ribbon cables or audio cables.
- ❑ 3. If you did an especially great wire-stripping and soldering job on the plug, there's an even greater chance that you forgot to slip the outer shell on the cable before soldering.
- ❑ 4. The causes of faulty cable assemblies are these:
  - Too much exposed wire, which gets bunched up against another connection AFTER the shell is screwed on.
  - Stray strands of wire.
  - Mixed up conductors.

Armed with that much wisdom from other folk's headaches, the following steps should now make a little more sense to you:

- ❑ 1. Slip the shells of BOTH plugs on the cable, making sure that they are pointed correctly.
- ❑ 2. Strip the MINIMUM of insulation needed from each end to make a clean, unstressed connection. That means NO excess wire that doesn't know where to go when the shell is put on.
- ❑ 3. The shield, which may either be braided or a bare wire in contact with a foil shield, is soldered to the same longer lug which clamps around the cable for mechanical strength.
- ❑ 4. The insulation colors of the two conductors may vary. All that is really important is that the same color of wire goes to the SAME solder point on BOTH plugs.
- ❑ 5. Be SURE after all soldering that there are no stray wire strands and no excess bare wire that can be pushed against another connection when the shell is screwed on.

- ❑ 6. Use needle-nose pliers to close both strain-relief clamps, but be sure you don't crush through the wire insulation!
- ❑ 7. Install both plug shells and check all connections with a VOM or continuity tester before using the cable.

## **MORE SG7 CABLE OPTIONS:**

The cable kit supplied with your SG7 will handle the majority of typical applications. However, "non-typical" applications can be even more fun and useful. So, we're pleased to clue you in on the fact that this cable can be as long as 300 feet, if that gives you more interesting "remote" speed-monitoring ideas. One ready-made cable and plug assembly (6-ft length) is Radio Shack No. 42-2157. A 50-ft. cable can be made for well under ten dollars from RS 278-1276 (Cable) and RS 274-284 (package of two plugs).

## **THE DC POWER SUPPLY:**

This is supposed to be the easy part that we all take for granted, but it is a good idea to work out your power supply in advance and wire it to the power plug supplied with your kit, so as not to become all wrapped up in haywire or trying to use weak batteries when the moment comes to field-test your SG7.

Assuming that you will be using the SG7 as a portable instrument, you'll want some style of battery power supply to permit convenient and practical operation. For optimum range and sensitivity, the unit requires an honest 12-14 volts, drawing a steady 150mA with earphone output, and 115mA without such audio output. Suggested voltage sources include:

- Automobile lighter/accessory cord
- 8 (or 9) Alkaline "D" Cells (best) or "C" Cells.
- Two 6-volt or one 12-volt lantern battery
- Various commercial or surplus 12-volt NiCad packs (such as for video cameras, two-way equipment, cellular telephones)

For light, occasional use, fresh "AA" alkaline batteries offer a very compact source of DC power. While rated for 200mA, such batteries really are not adequate for prolonged operation, as the voltage will begin to drop after ten minutes or so.

Note on AA,C and D cells: While we generally assume that 8 of these batteries can provide 12 volts, the truth is usually closer to 11 volts. An extra cell of the same size and type in series with your multiple-cell battery holders will assure optimum performance of the SG7 or other devices designed for 12 volts. Radio Shack carries a line of inexpensive battery holders in a variety of configurations.

Your battery power supply can be enclosed in whatever style of pack that suits your needs, tastes and budget. Discount-priced camera accessory bags are ideal for this purpose. Consider using a case with an extra pouch for storing the SG7 Speed Readout Unit, earphone, cables, etc. It is entirely up to you whether to install a switch in the battery cable.

## **A NOTE ABOUT TOOLS FOR THIS KIT:**

For easiest assembly of the SG7, we suggest this listing of tools to have on hand, borrow or buy:

### **A. BASIC PC BOARD WIRING**

1. Needle-nose plier
2. Tweezers
3. Wire nippers
4. Thin-diameter solder
5. Illuminated magnifier or very good eyes

### **B. SOLDERING EQUIPMENT**

1. Variable-temperature soldering station, or a selection of soldering tools or points capable of handling:
  - a small tip for the numerous DIP IC connections
  - a medium tip and heat for oscillator PC board
  - high heat for soldering metal cans
2. Basic de-soldering tool of some kind

### **C. ADDITIONAL TOOLS**

1. Wire brush and steel wool for cleaning metal can surfaces
2. 1/4-inch drill (for antenna hole in coffee cans)
3. Alignment tool or miniature screwdriver
4. Metal straight edge (for bending oscillator shield)
5. Accurate ruler
6. Medium-small phillips screwdriver

**LED SCHEMATIC DIAGRAM:**

# LED PARTS LAYOUT DIAGRAM:

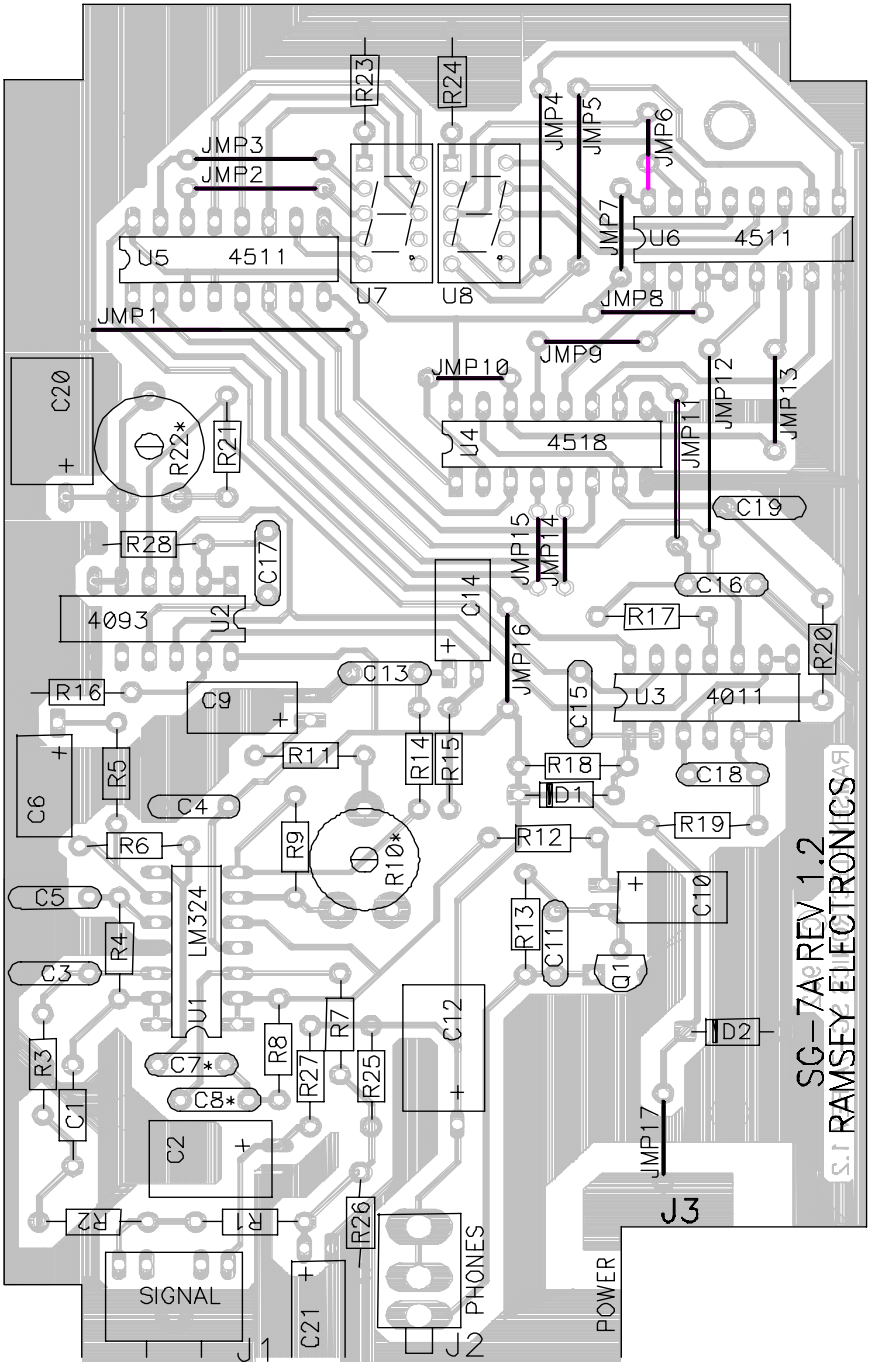

## **BUILDING THE LED SPEED READOUT UNIT:**

There are FOUR basic considerations in assembling this PC board:

1. Good, basic PC board construction technique.
2. Avoiding or repairing "solder bridges" on 110 different IC or LED display solder points.
3. A smooth fit of the PC board into its custom-designed case, which requires observing assembly directions and understanding the design of the completed unit. Mostly, this calls for the horizontal installation of electrolytic capacitors.
4. Planning for and understanding the need for a large number of "jumper" wires in this circuit board design.

In general, assembly of this PC board is quite conventional, but we'll show you special steps for a solid, well-fitting installation of the 12-volt power jack.

We encourage you to follow our suggested order of assembly.

### **PC BOARD ASSEMBLY:**

- 1. Install J2, the audio monitoring jack. Solder all three points. It's easy and a good start.
- 2a. Examine J1, the 3-conductor jack for interconnection with the microwave oscillator or "radar gun" unit of this project. The little plastic "legs" on the bottom of the jack should be removed, which is easy with wire nippers or even an emery board. We suggest using a touch of glue on the underside of the smoothed-out jack body. The purpose of this extra TLC is to make J2 as rugged as possible for repeated plugging in/out.
- 2b. Install 3-conductor jack J1 per step 2a.
- 3. Installation of ICs or IC sockets. Using good technique, the 6 ICs can be safely and easily soldered directly to the PC board. If you prefer to use sockets, you will need three 14-pin sockets. Sockets need to be treated with the same careful attention as the ICs themselves, both in soldering and IC insertion. For all socket or IC installations, press the device in its holes so that the body is flush against the board. While holding it in place, slightly bend the pins in the four corners to hold it in place for soldering. Use good lighting and a very clean solder tip. Take short breaks as needed so that the quality of your work remains consistent and solder bridges are avoided.

**IN THE FOLLOWING STEPS, BE SURE THAT THE NOTCHED, DOTTED OR BANDED END OF EACH IC IS ORIENTED AS SHOWN ON THE PC DRAWING!!!**

- ❑ Step 1: Install U1, 14-pin IC, type LM324.
- ❑ Step 2: Install U2, 14-pin IC, type MC14093 (or CD4093).
- ❑ Step 3: Install U3, 14-pin IC, type 4011.
- ❑ Step 4: Install U4, 16-pin IC, type 4518.
- ❑ Step 5: Install U5, 16-pin IC, type 4511.
- ❑ Step 6: Install U6, 16-pin IC, type 4511.

IN THE FOLLOWING STEPS, BE SURE THAT THE ORIENTATION DOTS ON THE LED DISPLAYS ARE POSITIONED AS SHOWN ON THE PC BOARD DRAWING!!!

- ❑ Step 7: Install U7, 7-segment LED display.
- ❑ Step 8: Install U8, 7-segment LED display.

The installation of U5 through U8 clarifies the locations of 15 of the 17 bare jumper wires to be installed. Be sure to save all the excess wire trimmed from resistors and capacitors. The jumpers will be installed toward the end of the assembly process when it is most likely you will have plenty of wire.

- ❑ 4. Install R1, 47K ohm resistor [yellow-violet-orange].
- ❑ 5. Install R2, 47K ohm resistor [yellow-violet-orange].
- ❑ 6a. When installing C2, 100 to 220 $\mu$ F, remember that ALL of the electrolytic capacitors are to be installed on their sides as shown on the PC board drawing. Keep the exposed wires as short as possible and observe correct polarity.
- ❑ 6b. Install C2, 100 to 220 $\mu$ F electrolytic capacitor, observe correct polarity.
- ❑ 7. Install C1, .005 or .0047 $\mu$ F disc capacitor (marked .005, .0047, 502 or 472).
- ❑ 8. Install R3, 47K ohm resistor [yellow-violet-orange].
- ❑ 9. Install R4, 47K ohm resistor [yellow-violet-orange].
- ❑ 10. Install C3, .001 $\mu$ F disc capacitor (marked .001 or 102).
- ❑ 11. Install C5, 2200pF disc capacitor (marked .0022, 2200 or 222).
- ❑ 12. Install C7, .05 or .047 $\mu$ F disc capacitor (marked .05, .047, 503 or 473).
- ❑ 13. Install C8, .05 or .047 $\mu$ F disc capacitor (marked .05 or .047 or 503 or 473). If C7 and C8 are large size (greater than the size of a "dime") disc capacitors, they should be mounted on the solder side of the PC board to ensure a good fit of the case.

- 14. Install R6, 1 megohm resistor [brown-black-green].
- 15. Install R8, 22K ohm resistor [red-red-orange].
- 16. Install R27, 220 ohm resistor [red-red-brown].
- 17. Install R9, 22K ohm resistor [red-red-orange].
- 18a. Examine the two small potentiometers. While they may be identical in appearance, one is stamped 2.2K (R10, Sensitivity Control), and the other is 10K (Calibration Control). Both of these controls are mounted on the solder-side of the board so that adjustments can be made without completely disassembling the LED Speed Readout unit.
- 18b. Install R10, 2.2K potentiometer per step 18a.
- 19. Between J1 and J2, install C21, 10 $\mu$ F electrolytic capacitor, observe polarity.
- 20. Install R26, 4.7K ohm resistor [yellow-violet-red].
- 21. Install R25, 4.7K ohm resistor [yellow-violet-red].
- 22. Install R7, 100K ohm resistor [brown-black-yellow].
- 23. Install C12, 100 to 220 $\mu$ F electrolytic capacitor. Again, be certain to install this and other electrolytic capacitors horizontally.
- 24. Install C4, .01 $\mu$ F disk capacitor (marked .01 or 103 or 10nF).
- 25. Install R5, 10K ohm resistor [brown-black-orange].
- 26. Install R11, 100 ohm resistor [brown-black-brown].
- 27. Install C6, 10 $\mu$ F electrolytic capacitor.
- 28. Install C9, 10 $\mu$ F electrolytic capacitor.
- 29. Install R16, 100K [brown-black-yellow].
- 30. Install R14, 10K [brown-black-orange].
- 31. Install R15, 100K [brown-black-yellow].
- 32. Install C13, .01 $\mu$ F disc capacitor (marked 103 or .01 or 10nF).
- 33. Install C17, .01 $\mu$ F disc capacitor.
- 34. Install R28, 100K ohm resistor [brown-black-yellow].
- 35. Install R22, 10K ohms on the solder side. This is the other small potentiometer for Calibration Control.
- 36. Install R21, 10K ohm resistor [brown-black-orange].
- 37a. The correct value for electrolytic capacitor C20 is determined by the manufacturing code of the 4093-type IC chip actually supplied in your kit. Your kit may include either of two capacitors:

- If U2 is marked "CD4093", then C20 is 22 $\mu$ F electrolytic capacitor.
  - If U2 is marked "MC14093", the C20 is 33 $\mu$ F electrolytic capacitor.
- 37b. Install the correct value for C20 per 37a, observe correct polarity.

### PROGRESS SUMMARY:

By now, you have installed the majority of the individual components for the LED Speed Readout Unit. As you can see on the PC board drawings, installation of a large number of jumper wires is required, and their correct connections are seen most clearly in relation to the ICs. Jumpers act as miniature "electronic bridges" that carry signals over PC board traces. You can make a jumper from a scrap, clipped off component lead wire shaped into a small loop.

JUMPER WIRES: Mark off each one as installed, while proceeding with the remaining assembly steps:

- Jumper Wire No. 1
- Jumper Wire No. 10
- Jumper Wire No. 2
- Jumper Wire No. 11
- Jumper Wire No. 3
- Jumper Wire No. 12
- Jumper Wire No. 4
- Jumper Wire No. 13
- Jumper Wire No. 5
- Jumper Wire No. 14
- Jumper Wire No. 6
- Jumper Wire No. 15
- Jumper Wire No. 7
- Jumper Wire No. 16
- Jumper Wire No. 8
- Jumper Wire No. 17
- Jumper Wire No. 9

ALL JUMPER WIRES INSTALLED!!

- 38. Install C14, 10 $\mu$ F electrolytic capacitor, observe polarity.
- 39. Install R23, 220 ohm resistor [red-red-brown].

- ❑ 40. Install R24, 220 ohm resistor [red-red-brown].
- ❑ 41. Install C19, .01 $\mu$ F disc capacitor (marked .01 or 103 or 10nF).
- ❑ 42. Install C16, 100pF disc capacitor (marked 100 or 101).
- ❑ 43. Install R17, 10K ohm resistor [brown-black-orange].
- ❑ 44. Install R20, 47K ohm resistor [yellow-violet-orange].
- ❑ 45. Install C15, .01 $\mu$ F disc capacitor (marked .01 or 103 or 10nF).
- ❑ 46. Install R18, 47K ohm resistor [yellow-violet-orange].
- ❑ 47. Install D1, the small 1N4148 diode. Orient the banded (cathode) end Correctly as shown in the drawings.
- ❑ 48. Install C18, .01 $\mu$ F disc capacitor (marked .01 or 103 or 10nF).
- ❑ 49. Install R12, 3.3K ohm resistor [orange-orange-red].
- ❑ 50. Install R19, 100K ohm resistor [brown-black-yellow].
- ❑ 51. Install C10, 10 $\mu$ F electrolytic, observe polarity.
- ❑ 52. Install R13, 47K ohm resistor [yellow-violet-orange].
- ❑ 53. Install C11, .001 $\mu$ F (marked .001 or 102). .
- ❑ 54. Install Q1, 2N3904 transistor with the flat side oriented as shown on the PC board drawing. Press the transistor firmly into its holes, keeping wire leads as short as possible.
- ❑ 55. Install D2, type 1N4002 or 4002, the larger, remaining diode. Be sure that the banded (cathode) end is oriented correctly.
- ❑ 56a. Review the Jumper Wire list and the Parts layout diagram, making sure that all jumpers are installed correctly.
- ❑ 56b. Verify that all IC chips or sockets (U1- U8) are installed correctly.
- ❑ 57a. Install power jack, J3. This jack is surface-soldered between the ground foil and the PC board pad area connected to Jumper 17. The side of the jack with the middle (unused) connector faces away from the solder side of the board, leaving the smooth side nearly flush with the component

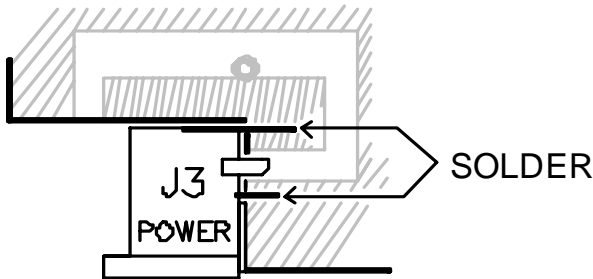

side. Do a trial positioning in order to understand how the jack is connected. Notice that the edges of the two jack lugs will be perpendicular to the PC board surface.

- ❑ 57b. The PC board areas to which the two outer jack lugs are to be soldered may be covered with a green coating called solder mask. If so, use a knife blade to gently scrape away the mask from the area shown down to bare shiny copper.
- ❑ 57c. "Tin" both copper areas with solder. A moderate buildup of solder is OK and will make installation of the jack easier. The two jack lugs may be tinned as well.
- ❑ 57d. After one more "fitting" by eye, solder ONE of the jack lugs in place. Re-melt and adjust as needed to get a good square positioning.
- ❑ 57e. With the jack looking good and secured at one lug, do a good job of soldering the other connection. Then, touch up the first connection if needed. Absolutely excellent solder joints are needed since these connections are the mechanical strength of J3's installation.

Wiring of the SG7 Speed Readout Unit PC board is now complete, but PLEASE follow our direction steps for installing this board in the custom case and panel supplied.

### **ASSEMBLING THE CASE AND PC BOARD:**

- ❑ 1. Mount the small red plastic lens filter. The red lens should neatly cover the LED window and is secured with a piece of tape to the inside of the case shell. Be sure the tape does not cover any part of the window area. We do not supply the tape, simply use a bit of scotch tape or electrical tape.
- ❑ 2. BEFORE peeling the backing off from the front panel decal, lay it in place to get an idea of the best positioning.
- ❑ 3. After removing the backing, lay one of the long edges in place on the case, making sure that the fit is straight and square. Then lay it down completely and gently smooth it into place. Do this carefully, since a second try would be difficult.
- ❑ 4. Select the four 4-40 screws and four standoffs. These screws go through the front panel decal and into the standoffs. Make neat starter holes through the decal using a sharp point such as a nail and mount the standoff spacers to the case front.
- ❑ 5. Mount the PC board to the threaded spacers, using the remaining four machine screws. The board should rest evenly on the spacers with no component pressing hard against the case.
- ❑ 6. Set aside the back shell and case screws until after initial tests and adjustments are completed. Note: If you wish extra protection for the front

panel decal, it may be sprayed with a fast-drying clear acrylic or urethane finish. Be sure to mask off the red lens window to avoid covering it with spray.

## **BUILDING THE SG7 MICROWAVE OSCILLATOR:**

Before beginning, study the PC board layout diagram on the next page. Some parts are mounted completely on the top side while others have one lead soldered to a strip on top and another passing through a hole for soldering on the solid tinned side. Here are some general suggestions to help assembly go as smoothly as possible:

1. Follow our suggested order of assembly. These steps are given to help you mount components as smoothly and neatly as possible.
2. A surface-mounted part can be secured most easily if the area to which it is to be soldered has been pre-tinned with enough solder to form a good connection. Otherwise, you will find yourself needing three hands in some cases.
3. Before soldering, it is best to do a careful test-fitting of the part, gently bending each lead for a neat, precise fit, and then PRE-TRIM the leads to their desired length. Your work will be much simpler, easier and neater if you follow this procedure. (However, the connections made on the solid tinned side should be trimmed after soldering.)
4. In all soldering to the solid tinned side of the board, use enough heat to let the solder flow freely to form a shiny and solid connection.
5. For easy identification, some of the tinned traces on the top of the board are identified by a double letter such as "AA".
6. Notice that C7, a .001 $\mu$ F SMT (Surface Mount Technology) chip capacitor, has been pre-installed at the factory. Be careful when soldering not to damage or dislodge it.

The first few steps are explained in greater detail to help you develop a good technique for proceeding more quickly after making a good beginning.

# MICROWAVE OSCILLATOR PARTS LAYOUT:

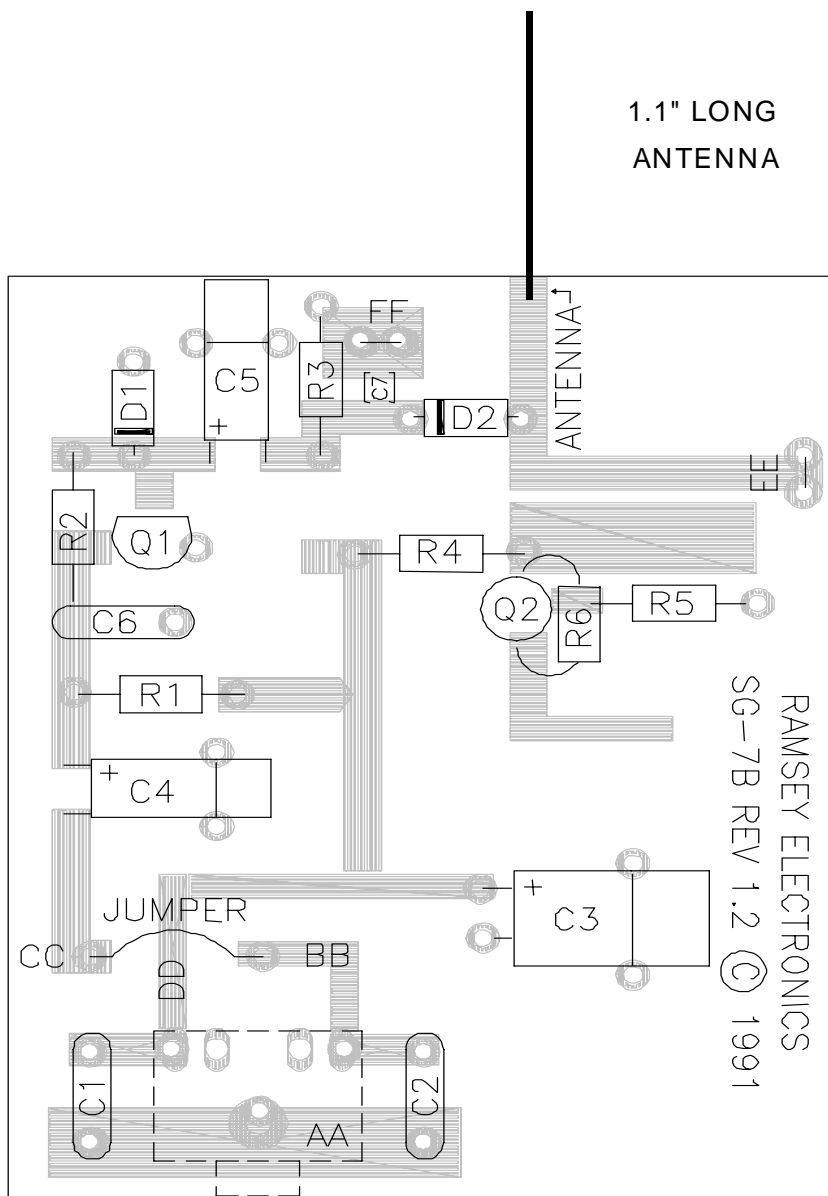

- ❑ 1a. Disc capacitors C1 and C2,  $.01\mu\text{F}$  (marked .01 or 103 or 10nF) are installed as a single operation. Notice that each has one lead going through the board and another to be soldered to a trace on the top. Also notice that the ground pin of the signal jack will be soldered to AA. Therefore the wire leads of C1 and C2 provide the ONLY connection between AA and the main ground plane and must be soldered on BOTH sides of the board.
- ❑ 1b. C1 and C2 are prepared as follows: Leave one lead wire straight, and bend the other lead to a right angle from its body. Do the same for the other capacitor. Select one capacitor and insert the straight lead through its hole on AA then trim the bent lead so that it sits in perfect position. Make sure just enough of the straight lead is exposed to permit a solid solder connection to AA. Solder all points in whichever order seems easiest.

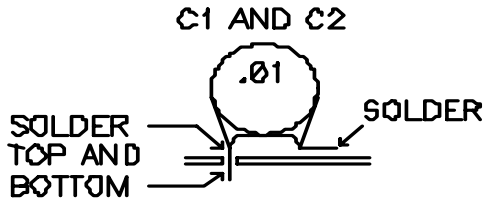

- ❑ 1c. Install the other  $.01\mu\text{F}$  disc capacitor as explained above.
- ❑ 2a. Notice that C3, the  $220\mu\text{F}$  electrolytic capacitor, also has one wire above (+) and the other (-) below. This capacitor and the other two electrolytic capacitors are installed so that their sides lay flat on the board. In addition, notice that holes are provided for each capacitor position so that you can solder hold-down wires for mechanical stability. Whether you install the hold down wires first, or solder the capacitor connections is up to you. Do whatever is easiest, making sure you watch out for polarity and that exposed wires are no longer than needed. If you prefer, these capacitors may also be held in place with a small drop of adhesive, such as silicone cement. It is important that they not vibrate during operation.
- ❑ 2b. Install C3,  $220\mu\text{F}$  electrolytic capacitor, per 2a above.
- ❑ 3. Install C4,  $1\mu\text{F}$  electrolytic in the same manner as above. This is the first component for which both connections are made on the top side of the board.
- ❑ 4. Install C5,  $1\mu\text{F}$  electrolytic the same way.
- ❑ 5. Install R1, 10K ohms [brown-black-orange]. Remember that small parts are easier to surface-solder if the connections are pre-tinned and the wire leads are pre-formed and trimmed.
- ❑ 6. Install C6,  $.01\mu\text{F}$  Disc capacitor (marked .01 or 103 or 10nF).
- ❑ 7. Install R2, 1 megohm [brown-black-green].

- 8. Install D1, the 1N4148 diode. Be sure not to confuse it with the special 1SS99 hot carrier diode which is smaller and has black and blue color bands. Be sure that the banded (cathode) end is oriented correctly.
- 9. Install Q1, 2N3904 transistor. The flat side must face D1, and the lead wires of the transistor must be soldered on BOTH sides of the PC board. Pre-form the leads and it will sit in position very nicely for soldering.
- 10. Install R3, 1K ohms [brown-black-red].
- 11. Install a jumper wire from BB to CC, taking care that it bridges PC board trace DD without touching it. Remember to pre-tin BB and CC and to handle the jumper with tweezers or pliers.
- 12a. Before installing the next 4 parts, study the arrangement of R4,R5, Q2 and R6. Install these parts in the order suggested.
- 12b. Install R4, 100 ohms [brown-black-brown].
- 12c. Install R5, 100 ohms [brown-black-brown].
- 13a. Before installing Q2, the NE021 transistor, make sure that all three connection points are pre-tinned and that there is sufficient solder tinning for easy installation of R6 after finishing Q2. Use tweezers to hold Q2 neatly in place for soldering.
- 13b. Install Q2 per 13a. above.
- 14. Install R6, 10K ohms [brown-black-orange].
- 15a. Notice the pairs of holes at points EE and FF. At both points, a small U-shaped jumper is installed and soldered on BOTH sides of the board. (Folks like me who are not microwave geniuses might wonder why the PC board trace for the antenna is shorted out straight to ground. The answer is that this circuit trace as well as the adjacent strips for the base and collector of Q2 are actual circuit components! Notice the schematic).
- 15b. Using bare scrap wire, install the jumper at EE.
- 15c. Install the jumper at FF. Be quick and CAREFUL so as not to damage C7, the factory-installed SMT chip capacitor.
- 16a. A length of tinned wire is supplied with your kit and is soldered to point GG and trimmed to form the 2600MHz antenna. In soldering, concentrate on keeping the wire straight and centered on the tinned strip. About 1/2-inch of the wire should be soldered solidly to the strip.
- 16b. Solder the antenna wire per 16a.
- 16c. Trim the antenna lead wire to 1.1 inches from the edge of the board. Measure carefully and cut the wire as required.
- 17a. Careful installation of D2, 1SS99 (marked with black and blue bands)

is important for several reasons. If it is damaged, your project will be on hold until you can get a replacement from us. Also, lead wires MUST be kept as short as possible - and its cathode end is soldered very near the SMT chip capacitor. Its glass body is very fragile, so be careful!

- ❑ 17b. After considering the concerns in step 17a., carefully install diode D2, making sure the banded (cathode) end is toward C7.

CONGRATULATIONS! You have completed construction of a 2.6GHz. microstrip oscillator. It is ready for its shielding cover, but - DO NOT install the cover until completing several voltage tests explained below.

The following tests require completion of the SG7 Speed Readout circuit board, correct preparation of the 2-conductor shielded cable set, and a reliable 12 volt, 200 ma minimum power source:

- ❑ 1. First, make sure that the voltage to the Speed Readout unit is a healthy 12-13 volts, not "10 or 11 volts or so". You will NOT get acceptable readings with a lower supply voltage, and you cannot do anything else useful with this PC board until it is enclosed and properly soldered to the antenna housing. Verify the following voltages on the microwave oscillator board:
- ❑ 2. Strip DD: 8 volts DC
- ❑ 3. Collector of Q1: about 3.7 volts
- ❑ 4. Collector of Q2: about 6 volts (5.5 to 6.5 is OK)
- ❑ 5. Base of Q2: 2.3 to 2.7 volts

Once you verify the above voltage readings, you can proceed to the section on installing the shielding cover. Before doing so, take one last and critical look at the quality of all solder points. And be VERY sure that there are no bits of wire or solder tucked under a resistor or capacitor.

## **FORMING AND INSTALLING THE MICROWAVE OSCILLATOR SHIELD:**

If you are used to making your own metal chassis projects, just what to do with the pre-cut oscillator cover will be obvious. Just get your bends going right from the start - or you will have to reverse them and risk weakening and distorting the bends. If you have never done something like this ever before, fear not. It's an easy process and even shows the basics of how a sheet-metal "brake" works. Such a metal brake is an even-pressure folding machine, whether used to make electronic chassis or heating/air conditioning ductwork!

The idea is to fold the 4 "flaps" to a clean 90-degree angle from the "top" so that the finished assembly makes a snug-fitting cover for the SG7B Microstrip Oscillator Board. The cover goes over the component side of the PC board, so that the shiny ground-plane side of the board and cover form a neat box, with

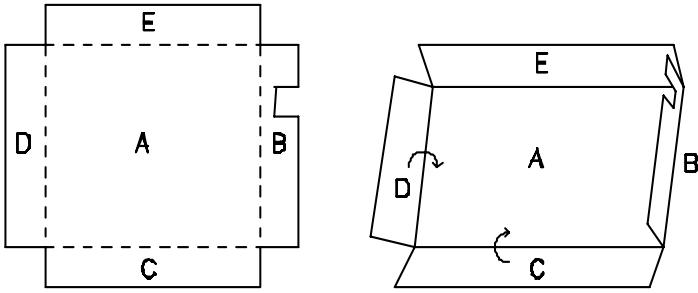

the 1.1" antenna extending neatly through the pre-cut notch.

While the first one or two bends can be made using a small hobby vise, the process will show you why you need some kind of rigid straight edge to complete the job.

**IMPORTANT:** While the metal is easy to bend and you are strong and healthy, your two thumbs are NOT a smooth-metal bending tool. A pair of solid, even forming edges are required for a straight bend. One edge remains stationary, and the other edge moves an entire flap evenly into correct position.

Because the shield needs to be soldered securely to the outer side of the PC board, it is useful to bend each flap slightly more in toward the center, so that the four sides formed by these flaps can grip the PC board in position for easy soldering.

### **MOUNTING THE MICROSTRIP OSCILLATOR:**

Performing this operation correctly is absolutely essential to achieving specified performance and range of the Ramsey SG7 Personal Speed Radar. Please follow our directions!

- 1. Drill a 1/4" hole (no larger) at a distance 1-7/8" from the closed end of the can. Most coffee cans have indented rings, 1-7/8" is the 2nd ring from the bottom of the can.
- 2. If there is paint on the can, whether it is your's or the coffee company's, it must be removed from the 1" X 2" area to which the oscillator assembly will be soldered.
- 3. Use emery paper and/or a stiff wire brush to clean thoroughly the area to be soldered.
- 4. Tin the area to be soldered. An ordinary soldering pencil will work fine for both tinning and soldering work. It can also be helpful to pre-tin one or two of the points on the oscillator assembly that will be soldered to the can.
- 5. With the oscillator assembly positioned in a straight line (parallel with the sides of the can), and the antenna centered in the 1/4" hole, solder them together at two points to hold the oscillator assembly in place.

- ❑ 6. Make a final check for straightness and antenna positioning.
- ❑ 7. Solder all 4 sides of the oscillator assembly to the can. A solid solder seam is as important for range as it is for mechanical strength. The solder must run fully along all edges where the oscillator box touches the can. Flow enough solder to fill in any can ribbing under the oscillator box.
- ❑ 8. Do not paint the oscillator assembly until you are positive that your SG7 is functioning as specified. Otherwise, any desoldering required will be needlessly complicated and messy.

**MICROWAVE OSCILLATOR SCHEMATIC DIAGRAM:**

## **MAKING THE METAL RADAR ANTENNA HOUSING:**

"What??? I paid all this money for an electronics kit and I'm now expected to solder some tin cans?"

Leaving this particular phase of building Speedy to your own craftsmanship is the only possible way we can bring you this kit project so inexpensively. How else, aside from using the common metal can, will we get a perfectly round metal tube with one end completely closed in? Of course, if precision sheet metal work is your craft or hobby, you can make a housing to suit your own standards which would be beyond what is possible for most other people.

The standard SG7 design is based on using two 1-pound (or 13 oz.) coffee cans. But, now that coffee is being packaged in just about everything else except the classic 1-pound can, we have compiled the following list of alternative can combinations.

<u>DESCRIPTION</u>	<u>(All diameters = 3.875"):</u>	<u>TOTAL LENGTH</u>
1	1-pound ("13 oz") coffee can	11"
2	40-ounce food cans	13"
1 ea.	coffee can and 40-oz. can	12"
1 ea.	40 oz. food can and 28-oz food can	11"

The can combination that has received long-term testing in a number of different units is the original coffee can combination. A rule of thumb is that the longer the completed can assembly, the sharper the focus of the radar gun, meaning that it has to be pointed more directly. An advantage of the 40 oz. and 28 oz. food cans is that they are generally bare metal with easily removed paper labels, making soldering and finishing that much easier. The 40 oz. cans are used typically for precooked pasta and bean products, while the 28 oz. cans are used for fruits and vegetables. Please use one of the can combinations recommended above, because we have no data to support the feasibility of other size cans.

## **SOLDERING THE CANS TOGETHER:**

A neat seam around the joint of the two metal cans will contribute to the good looks of your finished Speedy. A solid seam is needed for proper performance and range. These are the steps for making a good solder seam:

- 1. Clean both can rims thoroughly with a wire brush or other abrasive tool. Do this VERY THOROUGHLY!
- 2. Carefully remove any small dents (or get another can).

- ❑ 3. Line up the main seams of both cans in a straight line. (This is only for a better-looking job.)
- ❑ 4. With the two cans perfectly joined together, use several strips of masking or electrical tape to hold the rims steady.
- ❑ 5. In the centers of the exposed non-taped areas, make good, solid solder joints at least a half inch long.
- ❑ 6. Remove all tape and re-clean the areas to which the tape had adhered.
- ❑ 7. Patiently solder a solid seam around the entire perimeter of the joined can rims.
- ❑ 8. As you work, believe that it can be done and that it should be done! Yes, it CAN be done!

To keep it from being a frustrating ordeal, you may get some practice on two other un-needed cans before working on the SG7 itself. However, be sure to do the preparatory cleaning steps on the test cans just as thoroughly, or the solder will just roll up into little balls and laugh at you. (Also, you find that solder can adhere to the thinner can surface much more easily than to the reinforced rims!) The idea is to discover just how much heat you need and how slowly or quickly the soldering tip can be moved. Again, BE SURE to make the can rims clean and shiny before soldering.

A miniature hobby torch with a pin-point flame is an ideal tool. A standard propane torch seems to be entirely TOO MUCH even at its lowest setting. A soldering gun should work well, but I was getting better results with a 25-watt pencil iron than from a 75-watt gun. I also tried one of those portable butane soldering pens, but I would not recommend buying that tool just for this job.

A second soldering pencil can be used by a helper to intensify the heating of the can rims. (If you would like to be rebellious for once on an electronics project, and know that you can do a better job with solid or acid core solder, paste and torch, that's just fine - on THIS part of the SG7 project only! And, if you're already good at light welding-brazing, or know someone who is, then go for it!)

After the cans are soldered together, any rough spots in the soldered seam can be smoothed out, and the unit can then be painted or covered with contact paper. We remind you again not to do ANY painting around the oscillator assembly until correct operation is verified. You may wish to add a handle or tripod mount. These can be glued to the outside of the can, but a couple of small screwheads protruding within the can assembly will not disturb SG7 performance. The plastic lid of a coffee can will fit the open end of any of our recommended can combinations and will keep dirt and moisture out of the inside.

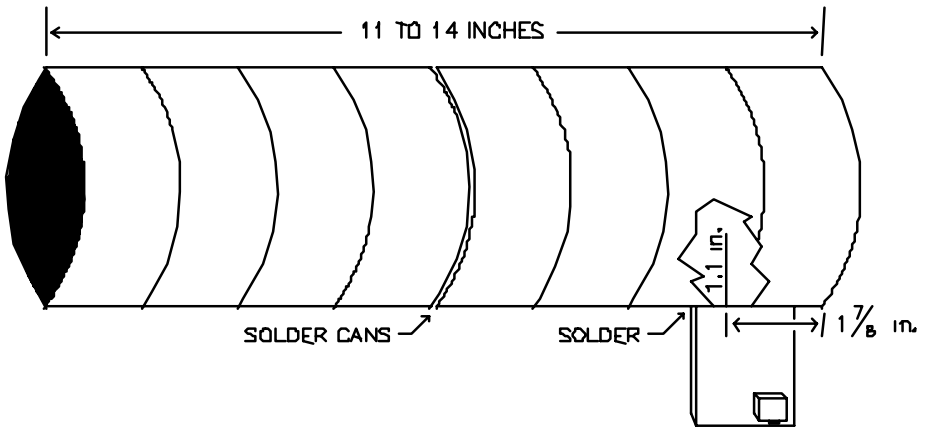

## TESTING AND CALIBRATION:

1. Connect an earphone to J2, using a subminiature plug or adapter.
2. Connect the counter and oscillator units together with the shielded 3-conductor cable already assembled.
3. While listening to the earphone, plug in the 12 volts DC cord. The LED displays should light right away. After a few seconds, you should hear a steady AC buzz in the earphone. Next, if you wave your hand in front of the open end of the antenna "can", you should hear a rapid series of clicks. The faster you move your hand toward the unit, the faster the rate of the clicks. You are hearing the Doppler effect at work.
4. While still indoors, point the unit toward a fluorescent light fixture and adjust the Calibration pot for an LED reading of 18. This provides a calibration of the speed counter.
5. It is normal for resistors R23 and R24 to be fairly warm to the touch.
6. The correct Doppler shift at the operating frequency of the SG7 is 7.76 Hz per mile-an-hour.
7. Due to the extreme high gain and sensitivity of the SG7, do remember that all indoor tests and usages will be affected by powerful AC 60 Hz power mains, lines and light flux!

## **FINAL CALIBRATION:**

To put it simply, the SG7 is calibrated by adjusting the control while pointing the antenna unit at a vehicle traveling at a steady, known speed. Obviously, the accuracy of the radar unit depends on the steadiness of the test drive and the accuracy of the vehicle's speedometer. To verify speedometer accuracy, use a stopwatch to time how long it takes the vehicle to travel a given distance and carry out the appropriate calculations.

If the speedometer accuracy seems questionable, and no other test vehicle is easily available, simply set up a safe test-run course to clock the car for a certain speed. For a test speed of 30 mph., the car would cover half of 5280 feet in a minute, (that is 2640 feet in 60 seconds) which would result in these test runs which are reasonable in length and sufficient time for accuracy:

$$2640/6 = 440 \text{ feet in } 10.0 \text{ seconds}$$

$$2640/10 = 264 \text{ feet in } 6.0 \text{ seconds}$$

$$2640/12 = 220 \text{ feet in } 5.0 \text{ seconds}$$

Believe the time-distance results rather than the speedometer. If the car consistently covers 440 feet in 10.0 seconds with the speedometer reading 27 mph, then have the driver drive at an indicated 27 mph as you calibrate the SG7 for 30 mph. You can use any test speed which is safe for the purpose, and the same procedure is used for kilometer/hour calibrations as well. A bicyclist maintaining an accurate speed in the 15-20 mph range can also do the job. If you are curious as to how radar guns are otherwise calibrated, the procedure requires the use of a test device able to generate a "false target"; simply a microwave signal of a known frequency that is different from the fundamental frequency of the radar gun being calibrated. Differences between the radar gun's frequency and the standard test frequencies of the calibrating device are marked as test standard speeds (25,35,55 mph, etc). A very informative construction article for exactly such a test device was published in the Electronics Experimenters Handbook, an annual publication of Radio-Electronics Magazine (Gernsback Pub., Inc., 500-B Bi- County Blvd. Farmingdale, NY 11735)

## **Gain control adjustment:**

After calibration, point the unit up into the air and adjust the gain control clockwise until you just start to see a reading of 3 or 4. This will set the gain at just below the maximum unstable point and give the best range. This adjustment is somewhat critical, so take your time in doing it.

## **TROUBLESHOOTING HINTS**

1. Instructions are provided for checking voltages on the microstrip oscillator board before soldering the cover on.
2. If operation is erratic, check the cable assembly, and be sure that you followed the instructions for trimming away the plastic legs on BOTH 3-conductor jacks. If this is not done, reliable solder connections are difficult to make.
3. If you don't hear anything in the earphone, check the earphone itself, the plug or adapter for J2, the orientation of the NPN transistor and the polarity of C10 and C12.
4. If you experience other problems in the counter display unit, please recheck the following in this order:
  - a. Correct orientation of ICs and 7- segment displays.
  - b. If sockets were used, check for bent IC pins.
  - c. Correct polarity of all electrolytic capacitors.
  - d. Correct orientation of D1 and D2.
  - e. Possibility of solder bridges, especially at ICs.
  - f. Forgotten solder joints.
  - g. Correct resistor values.
  - h. All jumper wires installed.
5. Common causes of major trouble:
  - a. Antenna shorted to can.
  - b. Defective 3-conductor cable assembly.
  - c. Reverse polarity on power cord.
  - d. Solder bridges.
  - e. Reversed diodes (BOTH PC boards).
6. If you experience poor range, check:
  - a. Correct length of antenna wire probe
  - b. SHORT lead length on the 1SS99 diode
  - c. Proper adjustment of the gain control pot
  - d. Clean, solid 12 volt power source
  - e. Be sure outside sources are not interfering with the SG7

## **MODIFICATIONS:**

We are always interested in any customer reports and suggestions on adaptations of the basic SG7 design. We do not recommend any circuit modifications and ask that you remember that modifications make your kit ineligible for factory repair. Our technicians are not able to get into telephone discussions of possible modification ideas, but we're always glad to reply by fax or mail to a few clearly-stated "yes-no" questions.

## **SG7 STATISTICS AND SPECIFICATIONS:**

**RANGE:** Properly constructed, the SG7's is a mile, depending on terrain, target size and obstruction.

**ACCURACY:** 1 mph from 10 to 99 mph.

**TARGET LOCK TIME:** For an accurate reading, the SG7 must be pointed at the oncoming target for at least 2/7 of a second.

**COUNTER UPDATE TIME:** 1/7 second.

**POWER SUPPLY:** 12-14 Volts DC at 150 ma.

**OPTIONAL CALIBRATIONS:** Resistor R21 may be changed to permit any of the following distance/combinations:

R21 = 10K	LED Readout = Miles per hour (standard)
R21 = 4.7K	LED Readout = Kilometers per hour or:
R21 = 4.7K	LED Readout = Feet per second
R21 = 15K	LED Readout = Meters per second.

**OUTPUT SIGNAL FREQUENCY:** The frequency of the output signal fed from the radar gun unit to the counter-readout unit is computed by this equation:

$$fd = 2.6 \times 10^9 (2v/c) \text{ where:}$$

v= target speed in meters-per-second

c = 3 X 10<sup>8</sup> meters-per-second

fd = Doppler shift frequency.

**MORE SIMPLY:** 1 MPH = 7.76 Hertz of Doppler shift frequency

**THEREFORE:** MPH = Total Doppler shift in Hz divided by 7.76.

**IMPORTANT MEASUREMENTS:**

- Antenna length =1.1 inch
- Antenna distance from back of can = 1.875 inch

## **USING THE SG7:**

The SG7 Personal Speed Radar is suitable for any application which comes within its specified range and accuracy. It was designed to be fun and educational and we assume that you will find your own uses for it, whether for sporting events, as a science fair project, scout troop project, or school/neighborhood volunteer safety patrols.

Remember that the purpose of ANY speed radar is to provide a speed indication that falls within reasonable tolerances. If absolute accuracy is required, there is no substitute for careful distance/time calculations using a stop watch on an exactly-measured course. If your SG7 is used in conjunction with any kind of volunteer traffic safety project, it is up to the users to cooperate with local police and other authorities and to be capable of testifying to the purpose and accuracy of the unit for a given situation. While it would be silly to make a big fuss over a reading of 17 in a 15 mph school zone, a reading of 30 or 35 would be a cause for concern, as would a reading of 50 in a 35 mph zone.

NOTE: Use caution and courtesy when clocking vehicles for any reason. Not only do you want to avoid getting run over, it can be very dangerous to startle an oncoming motorist. It is always best to use your SG7 as inconspicuously as possible.

Finally, who says you have to be standing still and pointing at a moving target? What would you see if you were sitting in the bow of a boat with the SG7 pointed at a fixed object within its range? Or had it mounted on the handlebars of a racing bike? Enjoy your Speedy Personal Radar!

If you enjoyed building this Ramsey kit, there are a lot more in our catalog - call or write for your copy!

# **The Ramsey Kit Warranty**

**Please read carefully BEFORE calling or writing in about your kit. Most problems can be solved without contacting the factory.**

Notice that this is not a "fine print" warranty. We want you to understand your rights and ours too! All Ramsey kits will work if assembled properly. The very fact that your kit includes this new manual is your assurance that a team of knowledgeable people have field-tested several "copies" of this kit straight from the Ramsey Inventory. If you need help, please read through your manual carefully. All information required to properly build and test your kit is contained within the pages!

**1. DEFECTIVE PARTS:** It's always easy to blame a part for a problem in your kit, Before you conclude that a part may be bad, thoroughly check your work. Today's semiconductors and passive components have reached incredibly high reliability levels, and it's sad to say that our human construction skills have not! But on rare occasions a sour component can slip through. All our kit parts carry the Ramsey Electronics Warranty that they are free from defects for a full ninety (90) days from the date of purchase. Defective parts will be replaced promptly at our expense. If you suspect any part to be defective, please mail it to our factory for testing and replacement. Please send only the defective part(s), not the entire kit. The part(s) MUST be returned to us in suitable condition for testing. Please be aware that testing can usually determine if the part was truly defective or damaged by assembly or usage. Don't be afraid of telling us that you 'blew-it', we're all human and in most cases, replacement parts are very reasonably priced.

**2. MISSING PARTS:** Before assuming a part value is incorrect, check the parts listing carefully to see if it is a critical value such as a specific coil or IC, or whether a RANGE of values is suitable (such as "100 to 500  $\mu$ F"). Often times, common sense will solve a mysterious missing part problem. If you're missing five 10K ohm resistors and received five extra 1K resistors, you can pretty much be assured that the '1K ohm' resistors are actually the 'missing' 10 K parts ("Hum-m-m, I guess the 'red' band really does look orange!") Ramsey Electronics project kits are packed with pride in the USA. If you believe we packed an incorrect part or omitted a part clearly indicated in your assembly manual as supplied with the basic kit by Ramsey, please write or call us with information on the part you need and proof of kit purchase.

### **3. FACTORY REPAIR OF ASSEMBLED KITS:**

To qualify for Ramsey Electronics factory repair, kits MUST:

1. NOT be assembled with acid core solder or flux.
2. NOT be modified in any manner.
3. BE returned in fully-assembled form, not partially assembled.
4. BE accompanied by the proper repair fee. No repair will be undertaken until we have received the MINIMUM repair fee (1 hour labor) of \$50.00, or authorization to charge it to your credit card account.
5. INCLUDE a description of the problem and legible return address. DO NOT send a separate letter; include all correspondence with the unit. Please do not include your own hardware such as non-Ramsey cabinets, knobs, cables, external battery packs and the like. Ramsey Electronics, Inc., reserves the right to refuse repair on ANY item in which we find excessive problems or damage due to construction methods. To assist customers in such situations, Ramsey Electronics, Inc., reserves the right to solve their needs on a case-by-case basis.

The repair is \$50.00 per hour, regardless of the cost of the kit. Please understand that our technicians are not volunteers and that set-up, testing, diagnosis, repair and repacking and paperwork can take nearly an hour of paid employee time on even a simple kit. Of course, if we find that a part was defective in manufacture, there will be no charge to repair your kit (But please realize that our technicians know the difference between a defective part and parts burned out or damaged through improper use or assembly).

**4. REFUNDS:** You are given ten (10) days to examine our products. If you are not satisfied, you may return your unassembled kit with all the parts and instructions and proof of purchase to the factory for a full refund. The return package should be packed securely. Insurance is recommended. Please do not cause needless delays, read all information carefully.

# SG7 PERSONAL SPEED RADAR KIT

## Quick Reference Page Guide

Introduction to the SG7 .....	4
Parts list.....	7
LED schematic diagram.....	12
LED unit PC layout.....	13
Assembling the LED unit.....	14
Assembling the microwave unit.....	20
Microwave unit PC layout.....	21
Microwave unit PC board.....	26
Testing and calibration.....	29
Troubleshooting hints.....	31
SG7 statistics and specs.....	32

### REQUIRED TOOLS

- Soldering Iron Ramsey WLC100
- Thin Rosin Core Solder Ramsey RTS12
- Needle Nose Pliers Ramsey MPP4 or RTS05
- Small Diagonal Cutters Ramsey RTS04  
<OR> Technician's Tool Kit TK405

**TOTAL SOLDER**  
**POINTS**  
**300**

**ESTIMATED**  
**ASSEMBLY TIME**  
**Beginner ..... 8.5 hrs**  
**Intermediate ..... 5.5 hrs**  
**Advanced..... 4.5 hrs**

### ADDITIONAL SUGGESTED ITEMS

- Holder for PC Board/Parts Ramsey HH3
- Desoldering Braid Ramsey RTS08
- Digital Multimeter Ramsey M133

Price: \$5.00

Ramsey Publication No. MSG7

Assembly and Instruction manual for:

***RAMSEY MODEL NO. SG7***

***PERSONAL SPEED RADAR KIT***

